

# Cable-Extension Position Transducer

DeviceNET®

Ranges: 0-75 to 0-550 inches

Industrial Grade

# PT9DN

## Specification Summary:

### GENERAL

Full Stroke Range Options—*on this datasheet* ..... 0-75 to 0-550 inches  
 Electrical Signal Interface ..... CANbus ISO 11898 Protocol  
 Protocol ..... DeviceNET Version 2.0  
 Accuracy ..... ± 0.10% full stroke  
 Repeatability ..... ± 0.02% full stroke  
 Resolution ..... ± 0.003% full stroke  
 Measuring Cable Options ..... nylon-coated stainless steel or thermoplastic  
 Enclosure Material ..... powder-painted aluminum or stainless steel  
 Sensor ..... plastic-hybrid precision potentiometer  
 Potentiometer Cycle Life ..... 250,000, min. —*before signal degradation can occur*  
 Maximum Retraction Acceleration ..... *see ordering information*  
 Maximum Velocity ..... *see ordering information*  
 Weight, Aluminum (Stainless Steel) Enclosure ..... 8 lbs. (16 lbs.) max.

### ELECTRICAL

Input Voltage ..... bus powered  
 Input Current ..... 40 mA  
 Address Setting/Node ID ..... 0...63 set via DIP switches —*default setting: 63*  
 Baud Rate ..... 125K, 250K or 500K set via DIP switches  
 EDS File ..... available @ <http://www.celesco.com/download>

### ENVIRONMENTAL

Enclosure ..... NEMA 4/4X/6, IP 67  
 Operating Temperature ..... -40° to 200°F (-40° to 90°C)  
 Vibration ..... up to 10 G's to 2000 Hz maximum



The PT9DN communicates via DeviceNET protocol with programmable controllers in factories and harsh environments requiring linear position measurements in ranges up to 550”.

As a member of Celesco’s innovative family of NEMA 4 rated cable-extension transducers, the PT9DN installs in minutes by simply mounting it’s body to a fixed surface and attaching it’s cable to the movable object. Perfect parallel alignment not required.

Fig. 1 – Outline Drawing (18 oz. cable tension only)

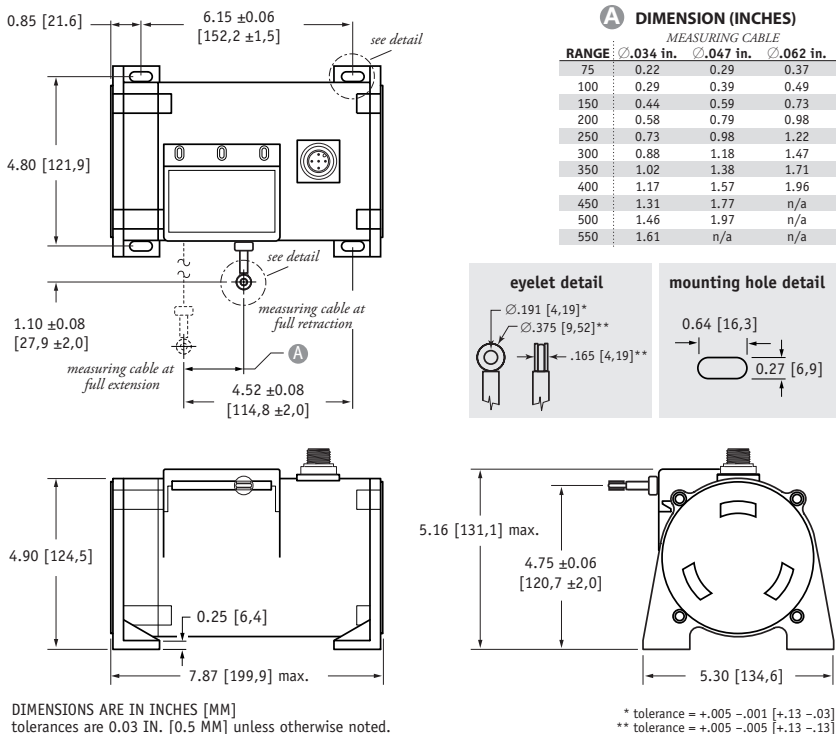

**I/O Format:**

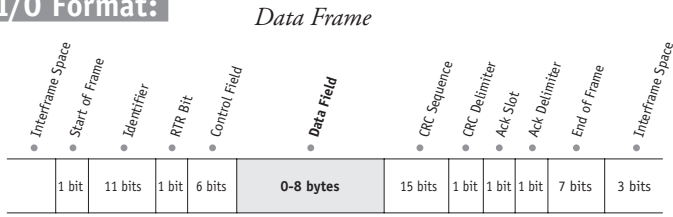

*Data Field*

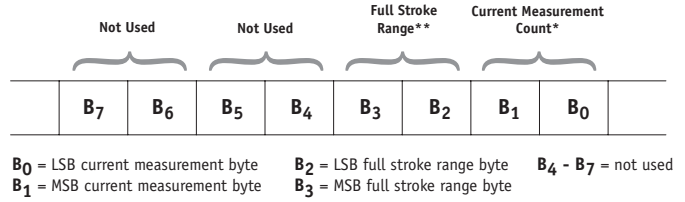

**\*Current Measurement Count**

The **Current Measurement Count (CMC)** is the output data that indicates the present position of the measuring cable.

The CMC is a 16-bit value that occupies the first two bytes (B<sub>0</sub> and B<sub>1</sub>) of the data field. B<sub>0</sub> is the LSB (least significant byte) and B<sub>1</sub> is the MSB (most significant byte).

The CMC starts at 0000H with the measuring cable fully retracted and continues upward to the end of the stroke range stopping at FFFFH. This holds true for all ranges.

**\*\*Full Stroke Range**

The **Full Stroke Range (FSR)** is a 16-bit value in the data field that expresses the full range of the sensor in inches. This value can be used to convert the actual count to units of measurement should the application require it.

The full stroke measurement range occupies the second two bytes (B<sub>2</sub> and B<sub>3</sub>) of the data field.

B<sub>2</sub> is the LSB (least significant byte) and B<sub>3</sub> is the MSB (most significant byte).

This value is expressed in inches.

Example:

Hex Value	Decimal Equivalent	Full Stroke Range
001E	30	30 inches

**Converting CMC to Inches**

If required, the CMC can easily be converted to a linear measurement expressed in inches instead of just counts.

This is accomplished by first dividing the CMC by 65,535 (total counts over the range) and then multiplying that value by the FSR:

$$\left( \frac{\text{CMC}}{65,535} \right) \times \text{FSR}$$

Example:

If the full stroke range is **30 inches** and the current position is **OFF2 Hex** (4082 Decimal) then,

$$\left( \frac{4082}{65,535} \right) \times 30.00 \text{ inches} = 1.87 \text{ inches}$$

**Address Setting (Node ID), Baud Rate and Bus Termination Settings**

**Address Setting (Node ID)**

The Address Setting (Node ID) is set via 6 switches located on the 8-pole DIP switch found on the DeviceNET controller board located inside the transducer.

The DIP switch settings are binary starting with switch number 1 (= 2<sup>0</sup>) and ending with switch number 6 (= 2<sup>5</sup>).

DIP-1 (2 <sup>0</sup> )	DIP-2 (2 <sup>1</sup> )	DIP-3 (2 <sup>2</sup> )	DIP-4 (2 <sup>3</sup> )	DIP-5 (2 <sup>4</sup> )	DIP-6 (2 <sup>5</sup> )	address (decimal)
0	0	0	0	0	0	0
1	0	0	0	0	0	1
0	1	0	0	0	0	2
...	...	...	...	...	...	...
1	1	1	1	1	1	63

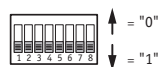

**Baud Rate**

The transmission baud rate may be either factory preset at the time of order or set manually at the time of installation.

The baud rate can be set using switches 7 & 8 on the 8-pole DIP switch found on the DeviceNET controller board located inside the transducer.

DIP-7	DIP-8	baud rate
0	0	125k
1	0	250k
0	1	500k
1	1	125k



**Bus Termination**

The setting of the internal bus termination resistor may be specified upon order or manually changed by the end user at the time of installation.

The bus termination resistor is activated setting switches 1 & 2 on the 2-pole DIP switch (located on the internal DeviceNET controller board) to the "ON" position.

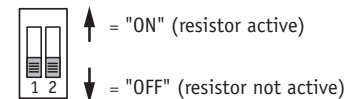

**DeviceNET Controller Board and DIP Switch Location**

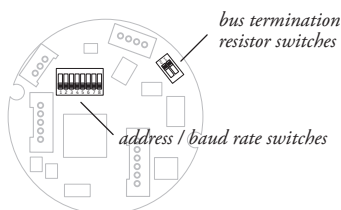

**Caution! Do Not Remove Spring-Side End Cover**  
removing spring-side end cover could cause spring to become unseated and permanently damaged.

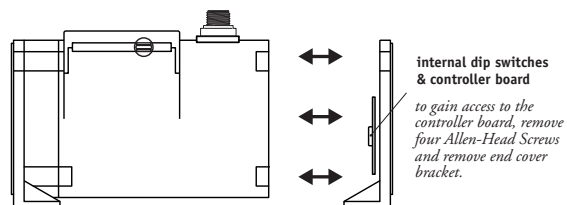

**Ordering Information:**

**Model Number:**

**PT9DN** - \_\_\_\_\_  
order code:            **R**        **A**        **B**        **C**        **D**        **E**        **F**        **G**

Sample Model Number:

**PT9DN - 200 - AL - N34 - 26 - FR - 500 - TR - SC5**

- R** range: 200 inches
- A** enclosure: aluminum
- B** measuring cable: .034 nylon-coated stainless
- C** measuring cable tension: 18 oz.
- D** cable exit: front (horizontal)
- E** baud rate: 500 k bits/sec.
- F** terminating resistor: yes
- G** electrical connection: 5-meter cordset with straight plug

**Full Stroke Range:**

<b>R</b> order code:	<b>75</b>	<b>100</b>	<b>150</b>	<b>200</b>	<b>250</b>	<b>300</b>	<b>350</b>	<b>400</b>	<b>450*</b>	<b>500*</b>	<b>550*</b>
full stroke range, min:	75 in.	100 in.	150 in.	200 in.	250 in.	300 in.	350 in.	400 in.	450 in.	500 in.	550 in.

\* – 36 oz. cable tension strongly recommended

**Enclosure Material:**

<b>A</b> order code:	<b>AL</b>	<b>SS</b>
	powder-painted aluminum	303 stainless

**Measuring Cable:**

<b>B</b> order code:	<b>N34</b>	<b>S47</b>	<b>V62</b>
	∅.034-inch nylon-coated stainless steel <i>available in all ranges</i>	∅.047-inch stainless steel <i>all ranges up to 500 inches</i>	∅.062-inch thermoplastic <i>all ranges up to 400 inches</i>

**Measuring Cable Tension:**

<b>C</b> order code:	<b>26</b>	<b>52</b>
tension (30%):	18 oz.	36 oz.
enclosure material:	aluminum        stainless steel	aluminum        stainless steel
max. acceleration:	1 G                .33 G	5 G                2 G
max. velocity:	60 inches/sec    20 inches/sec	200 inches/sec    80 inches/sec

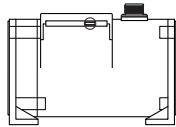

standard housing  
see fig 1.

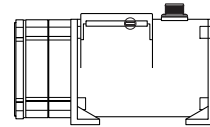

dual-spring housing  
see fig 2.

**Cable Exit:**

<b>D</b> order code:	<b>FR</b>	<b>UP</b>	<b>BK</b>	<b>DN</b>
	front	top	back	down

**Baud Rate:**

<b>E</b> order code:	<b>125</b>	<b>250</b>	<b>500</b>
	125 kbaud	250 kbaud	500 kbaud

**Ordering Information:**

**Terminating Resistor:**

Ⓔ order code:

TR

terminating resistor

NR

no terminating resistor

**Electrical Connection:**

Ⓔ order code:

blank

MC5

SC5

NC5

5-pin micro-connector  
(no mating plug supplied)

5-pin micro-connector  
w/ mating plug

5-pin micro-connector  
and 5 meter length cordset  
w/straight mating plug

5-pin micro-connector  
and 5 meter length cordset  
w/90° mating plug

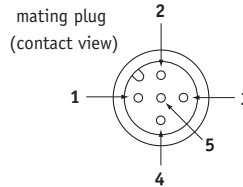
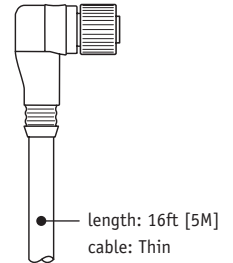
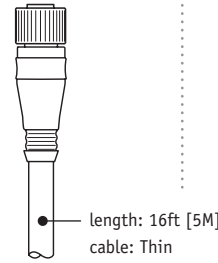
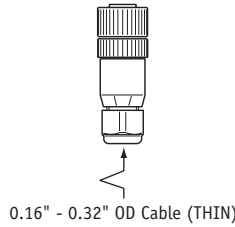
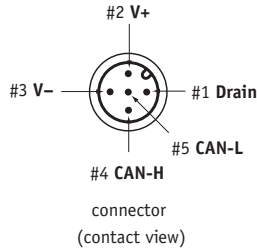

pin	signal	wire color
1	drain	brown
2	V+	white
3	V-	blue
4	Can-H	black
5	Can-L	grey

Fig. 2 – Outline Drawing (36 oz. cable tension only)

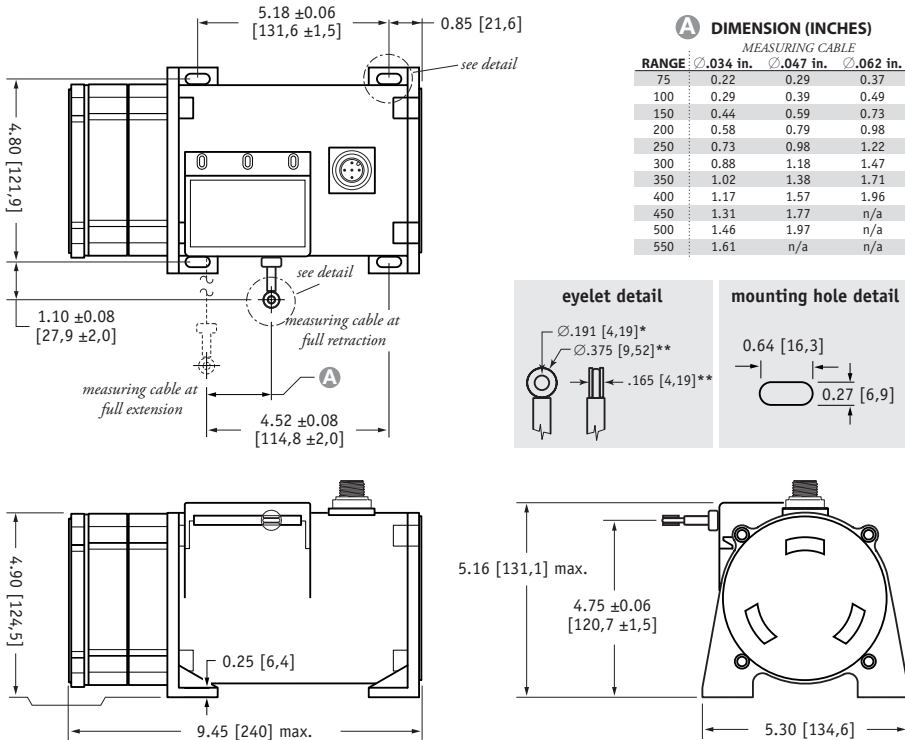

DIMENSIONS ARE IN INCHES [MM]  
tolerances are 0.03 IN. [0.5 MM] unless otherwise noted.

\* tolerance = +.005 -.001 [+,.13 -.03]  
\*\* tolerance = +.005 -.005 [+,.13 -.13]

version: 6.0 last updated: August 30, 2011