

Cable-Extension Position Transducer

RS232 Data Communication
Ranges: 0-10 to 0-250 inches
Industrial Grade

PT5232

Specification Summary:

GENERAL

Full Stroke Ranges..... 0-2 to 0-50 inches
 Electrical Interface..... RS232
 Format..... Hex
 Accuracy..... ± 0.75 to 0.18% full stroke
 Repeatability..... *see ordering information*
 Resolution..... $\pm 0.003\%$ full stroke
 Measuring Cable..... thermoplastic or stainless steel
 Enclosure Material..... hard-anodized aluminum
 Sensor..... plastic-hybrid precision potentiometer
 Potentiometer Cycle Life..... *see ordering information*
 Maximum Cable Velocity • Acceleration..... *see ordering information*
 Weight..... 5 lbs., max.

ELECTRICAL

Input Voltage..... 9...22 VDC
 Input Current..... 40 mA
 Baud Rate..... 9600 (selectable to 38.4K)
 Update Rate..... 32msec

ENVIRONMENTAL

Environmental Suitability..... NEMA 6, IP 67
 Operating Temperature..... -40° to 200° F (-40° to 90° C)
 Vibration..... up to 10 G's to 2000 Hz maximum



The PT5232, delivers position feedback via RS232 serial communication to your data acquisition or controller system. The PT5232 sends a raw 16-bit position count from 0000 to FFFF (hex). Additionally this device can be set to continuously send data or send data only when polled.

As the internal position sensing element is a precision potentiometer, this transducer maintains current accurate position even during power loss and does not need to be reset to a "home" position.

Outline Drawing

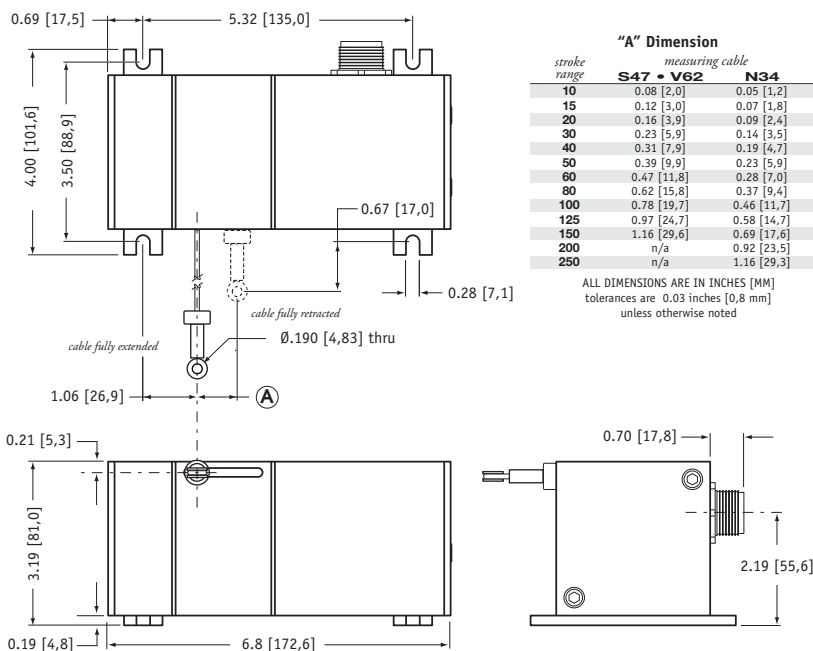

Output Signal

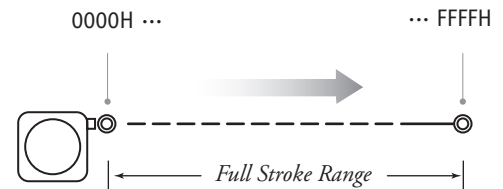

I/O Format:

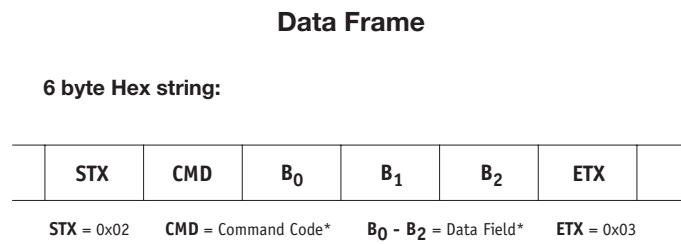
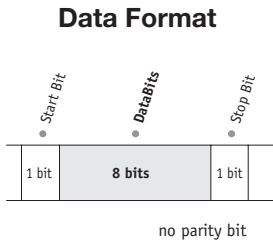

*-see below

Important! All communications to/from the transducer are in **HEX!**

User Commands:

Description	User Command				Sensor Response			
	<CMD>	<B ₀ >	<B ₁ >	<B ₂ >	<CMD>	<B ₀ >	<B ₁ >	<B ₂ >
Get Sensor Info	0x05	0x00	0x00	0x00	0x05	version ⁽⁴⁾	date ⁽⁵⁾	date ⁽⁵⁾
Get Serial Number	0x15	0x00	0x00	0x00	0x15	serial number ⁽³⁾		
Start Continuous Data	0x25	0x00	0x00	0x00	0x25	0x00	0x00	0x00
Stop Continuous Data	0x35	0x00	0x00	0x00	0x35	0x00	0x00	0x00
Get Position Data	0x45	0x00	0x00	0x00	0x45	CMC ⁽¹⁾	CMC ⁽¹⁾	status ⁽²⁾

(1) CMC - Current Measurement Count (Position)

The Current Measurement Count (CMC) is the output data that indicates the present position of the measuring cable.

The CMC is a 16-bit value that occupies the first two bytes (B₀ and B₁) of the data field. B₀ is the MSB (most significant byte) and B₁ is the LSB (least significant byte).

The CMC starts at 0000H with the measuring cable fully retracted and continues upward to the end of the stroke range stopping at FFFFH. This holds true for all ranges.

(2) Status

The status byte is used as a flag to indicate the validity of the position signal that the internal electronics receives from the potentiometer.

Flags are as follows:
0x00 = GREEN, 0x55 = YELLOW, 0xAA = RED

A "green" flag shows everything OK. A "yellow" or "red" flag indicates that the sensor has either been extended beyond its range or that there is a problem with the potentiometer.

(3) Serial Number

Each sensor has its own unique serial number. This information can be retrieved by sending the sensor the "Get Serial Number" command.

The serial number is a 3 byte value from which ranges from 0 to 9999999 (decimal).

(4) Version

This is a single byte value (0-255 decimal) which indicates the currently installed firmware version of the sensor.

(5) Date

This is a 2 byte value showing the date of currently installed firmware. This value ranges from 01011 - 12319 (decimal). Format is MMDDY. While the month and day are expressed as two digit numbers the year is expressed in a single digit only.

Example: 08054 = August 5, 2004

Baud Rate

The baud rate can be set using switches 7 & 8 on the 8-pole DIP switch found on the rs232 controller board located inside the transducer.

DIP-7	DIP-8	baud rate
0	0	9600
1	0	19200
0	1	38400
1	1	9600



RS232 Controller Board and DIP Switch Location

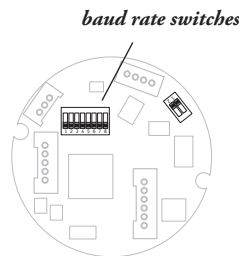

Caution! Do Not Remove Spring-Side End Cover
removing spring-side end cover could cause spring to become unsated and permanently damaged.

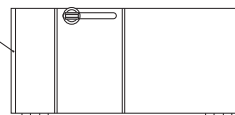

internal dip switches & controller board
to gain access to the controller board, remove four Allen-Head Screws and remove end cover bracket.

Ordering Information:

Model Number:

PT5232 - **R** - **A** - **B** - **C**
order code:

Sample Model Number:

PT5232 - 50 - N34 - UP - M6

- R** range: 50 inches
- A** measuring cable: .034 nylon-coated stainless
- B** measuring cable exit: up (top exit)
- C** electrical connection: 6-pin plastic connector

Full Stroke Range:

R <i>order code:</i>	10	15	20	25	30	40	50	60	80	100	125	150	200	250
full stroke range, min:	10 in.	15 in.	20 in.	25 in.	30 in.	40 in.	50 in.	60 in.	80 in.	100 in.	125 in.	150 in.	200 in.	250 in.
accuracy ($\pm\%$ of f.s.):	.75%	.6%	.5%	.5%	.5%	.3%	.3%	.25%	.25%	.25%	.25%	.18%	.18%	.18%
repeatability ($\pm\%$ of f.s.):	.1%	.1%	.05%	.05%	.05%	.05%	.05%	.02%	.02%	.02%	.02%	.02%	.02%	.02%
potentiometer cycle life:	2,500,000 cycles						500,000 cycles						250,000 cycles	
cable tension (20%):	41 ounces											21 ounces		
max. cable velocity/acceleration:	300 in./sec • 5 G's											120 in./sec • 2 G's		

Measuring Cable:

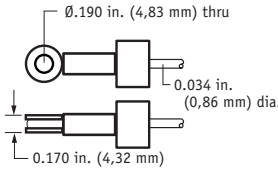
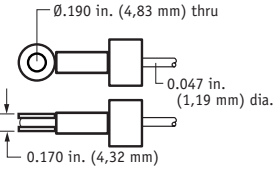
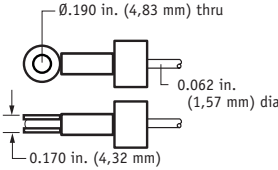
A <i>order code:</i>	N34	S47	V62
	.034 nylon-coated stainless steel <i>available in all ranges</i>	.047 stainless steel <i>all ranges up to 150 inches</i>	.062 thermoplastic <i>all ranges up to 150 inches</i>
			

Cable Exit:

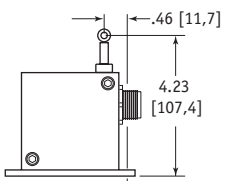
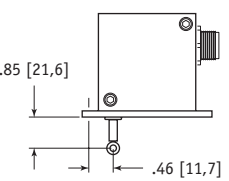
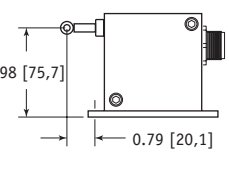
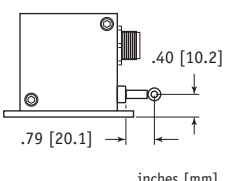
B <i>order code:</i>	UP	DN	FR	BK
	up	down	front	back
				
	inches [mm]			

Electrical Connection:

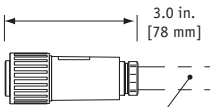
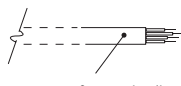
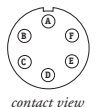
C <i>order code:</i>	M6	C25																												
	6-pin plastic connector with mating plug IP 67, NEMA 6	25-ft. instrumentation cable 24 AWG, shielded IP 67, NEMA 6																												
																														
	.30 - .39 in. [8 - 10 mm] cable dia. 16 AWG max conductor size connector: MS3102E-14S-6P mating plug: MS3106E-14S-6S	25 ft. x 0.2-in. dia. [7.5 M x 5 mm dia.] 24 AWG, shielded																												
	<table border="0"> <tr> <td>pin</td> <td>signal</td> </tr> <tr> <td>A</td> <td>9...22 VDC common</td> </tr> <tr> <td>B</td> <td>-</td> </tr> <tr> <td>C</td> <td>-</td> </tr> <tr> <td>D</td> <td>Transmitted Data</td> </tr> <tr> <td>E</td> <td>Received Data</td> </tr> <tr> <td>F</td> <td>common</td> </tr> </table>	pin	signal	A	9...22 VDC common	B	-	C	-	D	Transmitted Data	E	Received Data	F	common	<table border="0"> <tr> <td>color code</td> <td>signal</td> </tr> <tr> <td>Red</td> <td>9...22 VDC common</td> </tr> <tr> <td>Black</td> <td>common</td> </tr> <tr> <td>White</td> <td>-</td> </tr> <tr> <td>Green</td> <td>Transmitted Data</td> </tr> <tr> <td>Blue</td> <td>Received Data</td> </tr> <tr> <td>Brown</td> <td>common</td> </tr> </table>	color code	signal	Red	9...22 VDC common	Black	common	White	-	Green	Transmitted Data	Blue	Received Data	Brown	common
pin	signal																													
A	9...22 VDC common																													
B	-																													
C	-																													
D	Transmitted Data																													
E	Received Data																													
F	common																													
color code	signal																													
Red	9...22 VDC common																													
Black	common																													
White	-																													
Green	Transmitted Data																													
Blue	Received Data																													
Brown	common																													
																														
	contact view																													

version: 3.0 last updated: July 10, 2008

PT5232 | 99