

Inclinometer

4...20 mA Output • Hazardous Area Certification

Ranges: 0-45° to 0-240°

Industrial Grade



IT9420

Specification Summary:

GENERAL

Available Full Stroke Ranges 0-45 to 0-240 degrees
 Weight (aluminum enclosure)..... 5 lb. typical (aluminum enclosure)
 Enclosure Material.....aluminum (stainless steel available)
 Sensor precision potentiometer
 Electrical Connector..... MS3102E-14S-6P
 Mating Plug (included) MS3106E-14S-6S

ELECTRICAL

Output Signal 4...20 mA
 Input Voltage *see ordering information*
 Input Current..... 20 mA max.
 Circuit Protection.....38 mA maximum

PERFORMANCE

Sensitivity.....16 mA/full stroke, $\pm 0.25\%$
 Accuracy*..... $\pm 1\%$ full stroke
 Accuracy Option 0.5% full stroke—*please contact factory*
 Resolution essentially infinite
 Output Signal Adjustment for Full Stroke Ranges of 45° - 105°:
 Zero Adjustment from factory set zero to 20% of full stroke range
 Span Adjustment..... to 20% of factory set span
 Output Signal Adjustment for Full Stroke Ranges of 120° - 240°:
 Zero Adjustment from factory set zero to 40% of full stroke range
 Span Adjustment..... to 40% of factory set span
 *—when plane of pendulum motion parallel to plane of rotation within $\pm 3^\circ$

ENVIRONMENTAL

EnclosureNEMA 4/4X/6, IP 67/68
 Hazardous Area Certification *see ordering information*
 Operating Temperature -30° to 200°F (-34° to 90°C)
 Vibration..... up to 10 G's to 2000 Hz maximum



The model IT9420 is a rugged yet simple device which provides a 4 to 20 mA current feedback signal for incline position. The heart of the IT9420 is a magnetically-damped pendulum coupled to a conductive plastic precision potentiometer. A highly linear relationship between inclination and a 4 to 20 mA output is maintained over the full range of the IT9420.

The IT9420 is easy to use: simply attach it to the object of measurement and install two wires for the current loop.

Outline Drawing

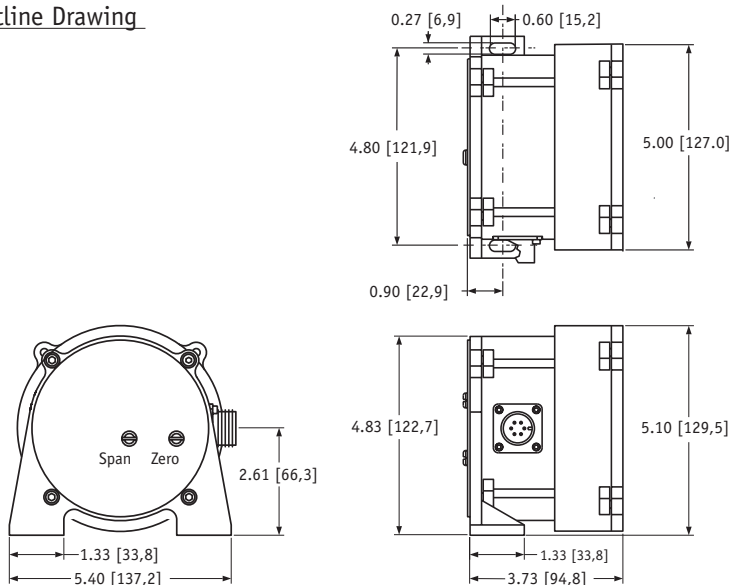

DIMENSIONS ARE IN INCHES [MM] tolerances are ± 0.02 in. [± 0.5 mm] unless otherwise specified

Output Signal

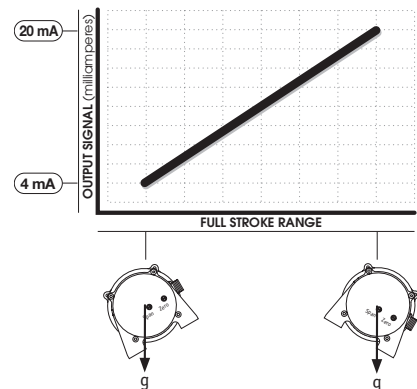

Ordering Information:

Model Number:

IT9420 - _____ - _____ - _____ - _____ - _____
 order code: CW CCW A B C D

Sample Model Number:
IT9420 - 060 - 120 - 1110

- CW** clockwise rotation: 60°
- CCW** counter-clockwise rotation: 120° } total rotation = 180°
- A** enclosure: aluminum
- B** output signal: 4 mA @ 120° CCW
20 mA @ 60° CW
- C** electrical connection: 6-pin plastic connector
- D** magnetic dampening: yes

Full Clockwise Rotation:

CW order code:	000	015	030	045	060	075	090	105	120
	0°	15°	30°	45°	60°	75°	90°	105°	120°

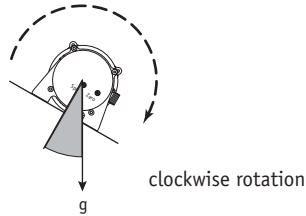

Important--
 the sum of the Clockwise and Counter-Clockwise Rotations must be in the range of 45° to 240°

Full Counter-Clockwise Rotation:

CCW order code:	000	015	030	045	060	075	090	105	120
	0°	15°	30°	45°	60°	75°	90°	105°	120°

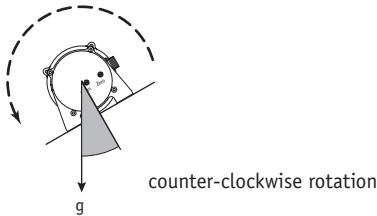

Important--
 the sum of the Clockwise and Counter-Clockwise Rotations must be in the range of 45° to 240°

Enclosure Material:

A order code:	1	2
	powder-painted aluminum	303 stainless steel

Output Signal:

B order code:	1	2	5	6
output signal options:	4...20 mA	20...4 mA	4...20 mA	20...4 mA
input voltage:	8 – 40 vdc		14 – 32 vdc	
hazardous area certification:	not certified		CSA Standard 22.2 Class 1 Groups A, B, C and D	Cenelec LCIE EEx ia IIC T4

***IMPORTANT:** intrinsically safe when powered from a CSA certified zener barrier rated 28 VDC max, 110 mA max per installation drawing#677984

Ordering Information:

Electrical Connection:

Ⓢ order code:

1

6-pin plastic connector w/mating plug
IP 67, NEMA 4X , 6**

3.0 in. [78 mm]

1/2 - 5/16" [14 - 8 mm] cable dia.
16 AWG max conductor size
connector: MS3102E-14S-6P
mating plug: MS3106E-14S-6S

2

10-ft. [3 M] waterproof cable
IP 67, NEMA 4X , 6**

10 ft. x 0.4-in. dia. [3 M x 10 mm dia.]
18 AWG, type SJTW

4

25-ft. [7.5 M] instrumentation cable
IP 67, NEMA 6

25 ft. x 0.2-in. dia. [7,5 M x 5 mm dia.]
24 AWG, shielded

Ⓢ order code:

5

100-ft. [30 M] waterproof cable
IP 67, NEMA 4X , 6**

100 ft. x 0.4-in. dia. [30 M x 10 mm dia.]
18 AWG, type SJTW

6

10-ft. [3 M] **pressure tested*** waterproof cable
IP 68, NEMA 4X , 6P**

10 ft. x 0.4-in. dia. [3 M x 10 mm dia.]
18 AWG, type SJTW

7

100-ft. [30 M] **pressure tested*** waterproof cable
IP 68, NEMA 4X , 6P**

100 ft. x 0.4-in. dia. [30 M x 10 mm dia.]
18 AWG, type SJTW

6-pin Mating Plug

pin	signal
A	8...40 vdc
B	4...20 mA out
C	-
D	case ground

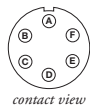

Waterproof Cable

color code	signal
WHITE	8...40 vdc
BLACK	4...20 mA out
GREEN	case ground

Instrumentation Cable

color code	2-wire
RED	8...40 vdc
BLACK	4...20 mA out
WHITE	n/a
GREEN	case ground

*-Test pressure: 100 feet [30 meters] H₂O (40 PSID) Test Medium: Air; Duration: 2 hours. ** -applies to stainless steel enclosure only.

Dampening Option:

Ⓢ order code:

0
with magnetic dampening

1
without magnetic dampening

Output Signal Selection:

The output signal direction can be reversed at any time by simply changing the dip-switch settings found on the internal signal board. After the settings have been changed, adjustment of the Zero and Span trim pots will be required to precisely match the 4 mA and 20mA signal values to the beginning and end points of the stroke.

To gain access to the signal board, remove four Allen-Head Screws and remove end cover bracket.

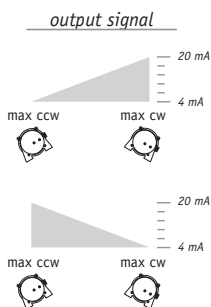

switch setting

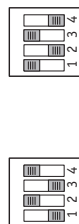

signal board

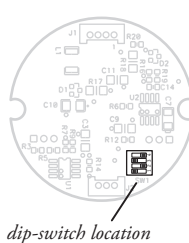

internal dip switches & signal board

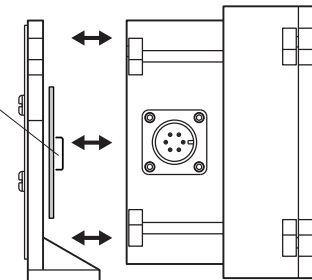

version: 3.0 last updated: October 17, 2007